



(12) **United States Patent**  
**Liu et al.**

(10) **Patent No.:** **US 9,270,436 B2**  
(45) **Date of Patent:** **Feb. 23, 2016**

- (54) **METHOD AND APPARATUS FOR CONFIGURING CELL-SPECIFIC REFERENCE SIGNAL**
- (75) Inventors: **Xuebin Liu**, Shenzhen (CN); **Lian Li**, Shenzhen (CN); **Hui Dong**, Shenzhen (CN)
- (73) Assignee: **ZTE Corporation**, Shenzhen, Guangdong (CN)
- (\* ) Notice: Subject to any disclaimer, the term of this patent is extended or adjusted under 35 U.S.C. 154(b) by 63 days.
- (21) Appl. No.: **14/128,186**
- (22) PCT Filed: **Oct. 24, 2011**
- (86) PCT No.: **PCT/CN2011/081202**  
§ 371 (c)(1),  
(2), (4) Date: **Dec. 20, 2013**
- (87) PCT Pub. No.: **WO2012/174813**  
PCT Pub. Date: **Dec. 27, 2012**
- (65) **Prior Publication Data**  
US 2014/0133426 A1 May 15, 2014
- (30) **Foreign Application Priority Data**  
Jun. 21, 2011 (CN) ..... 2011 1 0167316
- (51) **Int. Cl.**  
**H04L 5/00** (2006.01)  
**H04W 52/14** (2009.01)  
(Continued)
- (52) **U.S. Cl.**  
CPC ..... **H04L 5/0053** (2013.01); **H04L 5/005** (2013.01); **H04W 52/143** (2013.01); **H04W 52/16** (2013.01); **H04W 52/283** (2013.01); **H04W 52/325** (2013.01)
- (58) **Field of Classification Search**  
CPC ..... H04L 5/005; H04W 52/143  
USPC ..... 370/329  
See application file for complete search history.

- (56) **References Cited**  
U.S. PATENT DOCUMENTS  
2010/0097937 A1\* 4/2010 Pietraski et al. .... 370/241  
2014/0286185 A1\* 9/2014 Liu et al. .... 370/252  
FOREIGN PATENT DOCUMENTS  
CN 101801091 A 8/2010  
CN 101888690 A 11/2010  
(Continued)  
OTHER PUBLICATIONS  
Supplementary European Search Report in European application No. 11868245.9, mailed on Oct. 7, 2014. (4 pages—see entire document).  
(Continued)  
*Primary Examiner* — Melvin Marcelo  
*Assistant Examiner* — Peter Solinsky  
(74) *Attorney, Agent, or Firm* — Oppedahl Patent Law Firm LLC

(57) **ABSTRACT**  
The disclosure provides a method and an apparatus for configuring a Cell-Specific Reference Signal (CRS). The method includes: a cell is divided into a central area and a marginal area; a CRS is divided into a central CRS, a marginal CRS and a common CRS; a value that is obtained by adding a fixed first power value to a preset reference Energy Per Resource Element (EPRE) is configured as an EPRE value of the marginal CRS; a value that is obtained by subtracting a fixed second power value from the preset reference EPRE is configured as an EPRE value of the central CRS; and the reference EPRE is configured as the EPRE value of the common CRS. The disclosure can improve an SINR of a marginal area of a cell and enhance downlink performance of a UE in the marginal area of the cell, without affecting downlink performance of a UE in a central area of the cell.

**15 Claims, 4 Drawing Sheets**

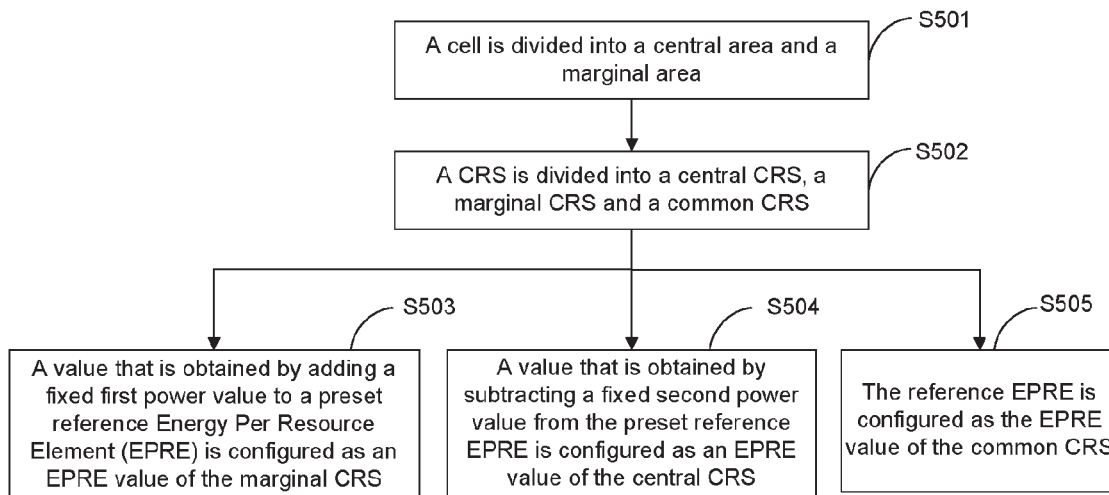

- (51) **Int. Cl.**  
*H04W 52/16* (2009.01)  
*H04W 52/28* (2009.01)  
*H04W 52/32* (2009.01)

JP 2010086905 A 4/2010  
JP 2011049744 A 3/2011

OTHER PUBLICATIONS

- (56) **References Cited**

FOREIGN PATENT DOCUMENTS

CN 101888692 A 11/2010  
JP 2006082637 A 3/2006  
JP 2006203274 A 8/2006

English Translation of the Written Opinion of the International Search Authority in international application No. PCT/CN2011/081202, mailed on Mar. 15, 2012. (4 pages—see entire document).  
International Search Report in international application No. PCT/CN2011/081202, mailed on Mar. 15, 2012. (3 pages—see entire document).

\* cited by examiner

Fig. 1

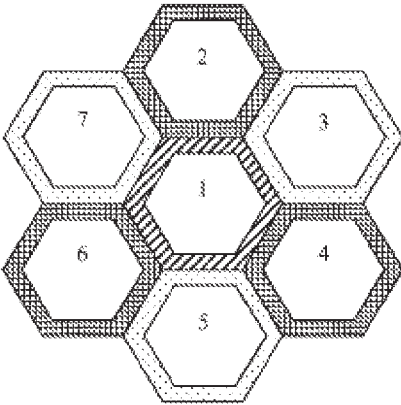

Fig. 2

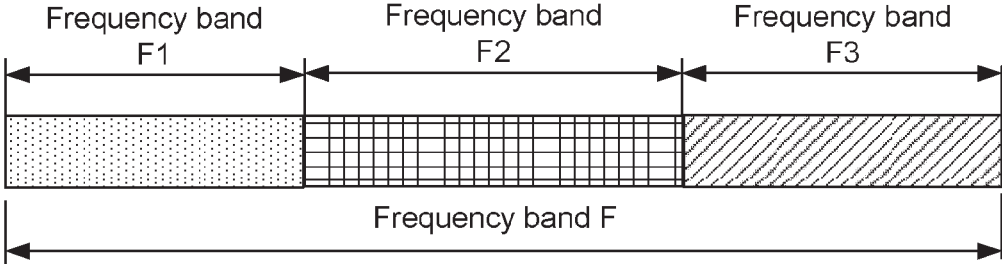

Fig. 3

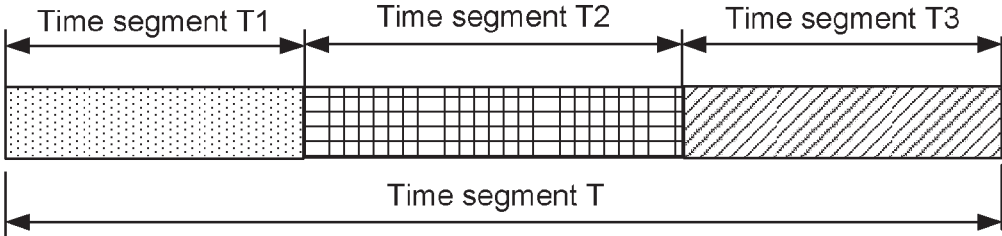

Fig. 4

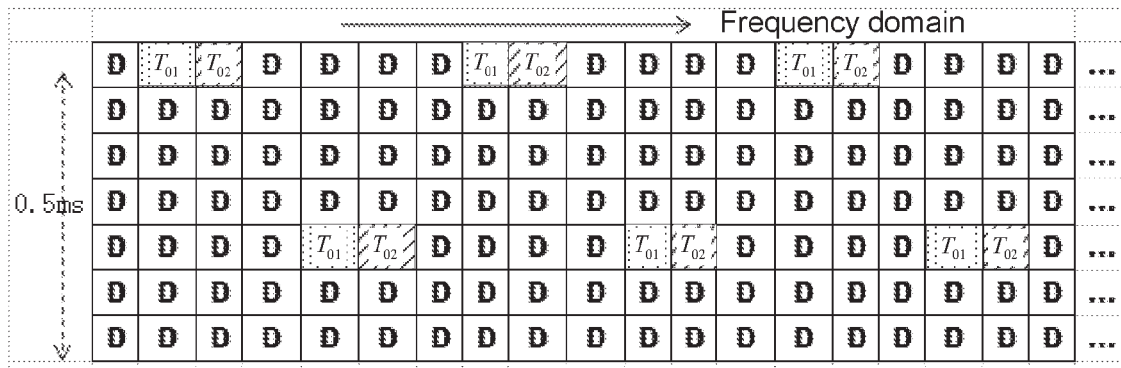

Fig. 5

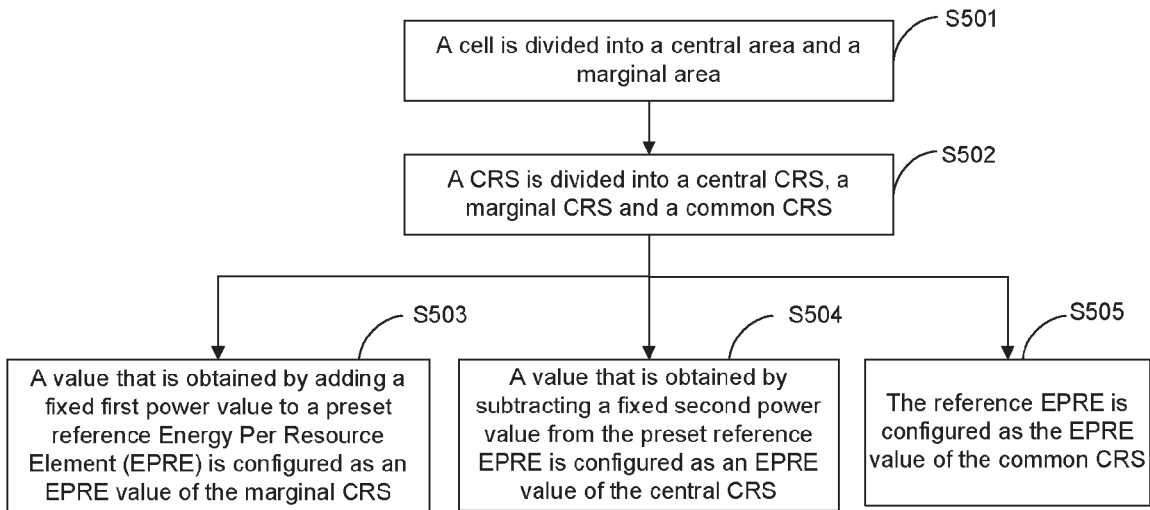

Fig. 6

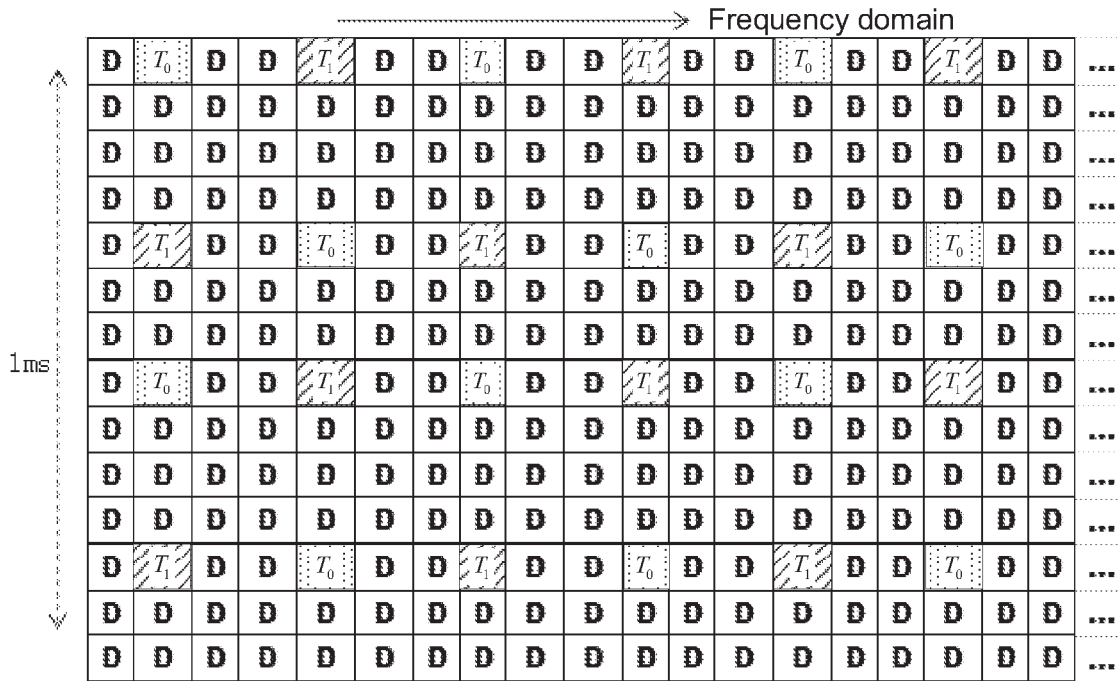

Fig. 7

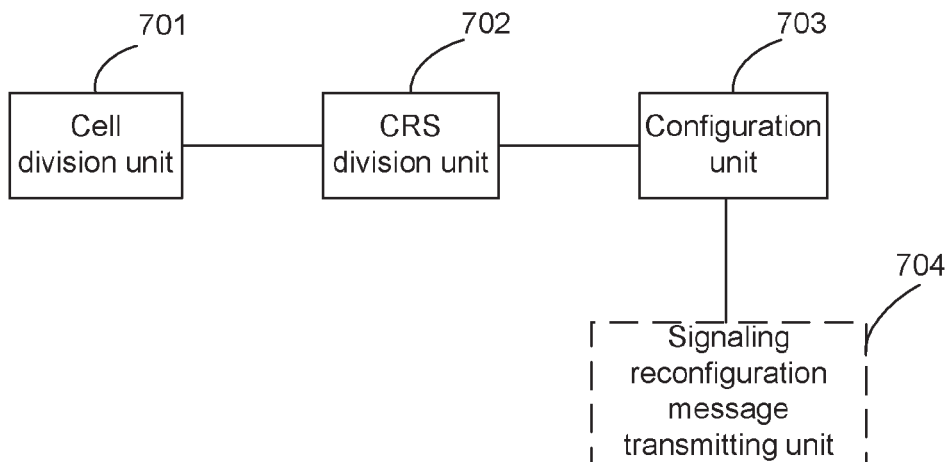

Fig. 8

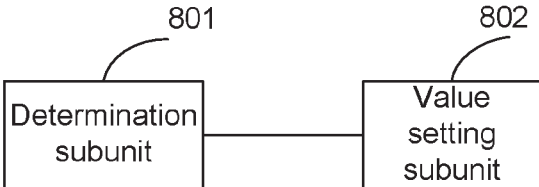
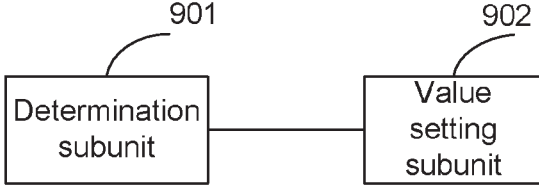

Fig. 9



# METHOD AND APPARATUS FOR CONFIGURING CELL-SPECIFIC REFERENCE SIGNAL

## TECHNICAL FIELD

The disclosure relates to the field of mobile communications, and in particular to a method and an apparatus for configuring a Cell-Specific Reference Signal (CRS).

## BACKGROUND

In a fourth-generation mobile communication Long Term Evolution (LTE) system, a Reference Signal (RS) is a pilot signal known to a receiving end, facilitating the receiving end to implement channel estimation and relevant measurement. The RS plays a very important role in demodulation of receiving signals, elimination of interference, improvement of a Signal Interference Noise Ratio (SINR), cell reselection and handover of a User Equipment (UE, also referred to as terminal) and the like.

There are many types of RSs in LTE. A CRS transmitted to a UE from an Evolved NodeB (eNB) of LTE is a common RS, which is continuously broadcasted in a cell to facilitate all UEs in the cell to estimate and measure quality of a downlink channel of the cell.

Compared with in third-generation mobile communications, a single cell can obtain a higher spectrum efficiency in LTE. However, in a co-channel network consisting of multiple cells contiguously, inter-cell interference is very serious, which significantly reduces the spectrum efficiency. Therefore, LTE put forwards Inter Cell Interference Coordination (ICIC) technology, as shown in FIG. 1. A cell is divided into a cell central area and a marginal area (a white area represents a central area, and an area with a textured pattern represents a marginal area; in some ICIC schemes, a cell is also divided into three areas, i.e., an inner circle, a middle circle and an outer circle). FIG. 1 shows 7 cells (i.e., cell 1 to cell 7), in which cell 1 and each of the other 6 cells (i.e., cell 2 to cell 7) are adjacent to each other. A UE in the central area of a cell can use total transmission resources, while a UE in the marginal area (i.e., a switching area connecting a neighbour cell) of the cell can only use a part of transmission resources. Moreover, resources used by UEs in marginal areas of adjacent cells are different, that is, the resources are orthogonal to each other.

Transmission resources might be frequency-domain resources, for example, frequency bands. FIG. 2 shows ICIC based on frequency domain, in which the entire frequency band F can be used in the central area of a cell while only a part of the entire frequency band (for example, F1, F2, or F3) can be used in the marginal area of the cell. Moreover, frequency band used in marginal areas of adjacent cells are different. Transmission resources may also be time-domain resources, for example, time segments. FIG. 3 shows ICIC based on time domain, in which the entire time segment T can be used in the central area of a cell while only a part of the entire time segment (for example, T1, T2, or T3) can be used in the marginal area of the cell. Moreover, time segments used in marginal areas of adjacent cells are different.

During specific implementation of ICIC in LTE, a specific power is generally set for a "dedicated channel" of a UE according to an area in which the UE is located. For example, in the ICIC based on frequency domain, a specific power is set for a Physical Downlink Shared Channel (PDSCH) allocated to a UE to bear UE dedicated data in a specific frequency band; in the ICIC based on time domain, specific powers are set for a Physical Downlink Control Channel (PDCCH) and a

PDSCH allocated to a UE to bear UE dedicated scheduling information and UE dedicated data in a specific time segment respectively. The specific setting is mainly to improve the power of marginal transmission resources and reduce the power of central transmission resources. However, no specific power is set for a common channel or common signal of all UEs in a cell, such as a Physical Broadcasting Channel (PBCH), a Physical Control Format Indicator Channel (PCFICH), a Physical Hybrid ARQ Indicator Channel (PHICH), a common PDCCH bearing scheduling information on a Broadcasting Channel (BCH) and a Paging Channel (PCH), a common PDSCH bearing data on a BCH and a PCH, and a CRS), that is, a reference power is adopted. The Energy per Resource Element (EPRE) of the CRS is generally a cell-level fixed value configured by a background network manager through network planning and network optimization, that is, the transmitting power of each Resource Element (RE) of the CRS is fixed and same by default.

However, the CRS would produce co-channel interference on other channels in a neighbour cell and which are on the same symbol with the CRS, such as a PDCCH and a PDSCH, this is because the CRS of a cell is generally staggered from that of a neighbour cell in frequency domain and no interference is generated between the CRSs. As shown in FIG. 4, each small square represents one RE, square  $T_{01}$  represents the RE of the CRS of cell 1, square  $T_{02}$  represents the RE of the CRS of cell 2, square D represents the RE of data, cell 1 and cell 2 are adjacent to each other, and the RE frequency domain position of the CRS of cell 1 is staggered from that of the CRS of cell 2. However, such configuration causes the CRS to conflict in frequency domain with a PDCCH, a PCFICH, a PHICH, a PDSCH or the like in a neighbour cell which is in the same symbol with the CRS, thereby producing co-channel interference. Since the CRS is continuously transmitted in time domain, frequency domain and spatial domain, interference impact does not allow to be ignored; particularly for a UE in the marginal area of a cell, interference is significant. According to theoretical analysis, system simulation and actual tests, even if in the condition of only one neighbour cell of no load, downlink throughput of a PDSCH for a UE in the marginal area of a cell would be reduced by half due to the interference of a CRS of a neighbour cell, and during inter-cell handover, the throughput is reduced more.

## SUMMARY

Embodiments of the disclosure provide a method and an apparatus for configuring a CRS, so as to solve the problem that an existing CRS produces co-channel interference on a dedicated channel and a common channel in a neighbour cell that are on the same symbol as the CRS.

A method for configuring a CRS provided by an embodiment of the disclosure includes:

a cell is divided into a central area and a marginal area; the CRS is divided into a central CRS, a marginal CRS and a common CRS, wherein the central CRS is a CRS located on the transmission resource section used by the central area of the cell and is on the same symbol as the dedicated channel of the central area; the marginal CRS is a CRS located on the transmission resource section used by the marginal area of the cell and is on the same symbol as the dedicated channel of the marginal area; and the common CRS is a CRS adjacent to and is on the same symbol as the frequency domain of the downlink common channel, other than the central CRS and the marginal CRS;

3

a value that is obtained by adding a fixed first power value to a preset reference Energy Per Resource Element (EPRE) is configured as an EPRE value of the marginal CRS;

a value that is obtained by subtracting a fixed second power value from the preset reference EPRE is configured as an EPRE value of the central CRS; and

the reference EPRE is configured as the EPRE value of the common CRS.

An apparatus for configuring a CRS provided by an embodiment of the disclosure includes:

a cell division unit, configured to divide a cell into a central area and a marginal area;

a CRS division unit, configured to divide the CRS into a central CRS, a marginal CRS and a common CRS, wherein the central CRS is a CRS which is located on a transmission resource section used in the central area of the cell and is on a same symbol as a dedicated channel of the central area; the marginal CRS is a CRS which is located on a transmission resource section used in the marginal area of the cell and is on a same symbol as a dedicated channel of the marginal area; and the common CRS is a CRS, except for the central CRS and the marginal CRS, which is adjacent to a downlink common channel in frequency domain and is on the same symbol as the downlink common channel; and

a configuration unit, configured to: configure a value that is obtained by adding a fixed first power value to a preset reference Energy Per Resource Element (EPRE), as an EPRE value of the marginal CRS; configure a value that is obtained by subtracting a fixed second power value from the preset reference EPRE, as an EPRE value of the central CRS; and configure the reference EPRE as an EPRE value of the common CRS.

The embodiments of the disclosure have advantages as follows:

with the method and the apparatus for configuring a CRS provided by the embodiments of the disclosure, the CRS is divided into a central CRS, a marginal CRS and a common CRS on the basis of dividing a cell into a central area and a marginal area in the existing ICIC technology, wherein the EPRE of the central CRS is reduced by certain power on the basis of a preset reference EPRE, and the EPRE of the marginal CRS is raised by certain power on the basis of the preset reference EPRE. Therefore, without affecting the downlink performance of a UE in the central area of a cell, an SINR of a marginal area of the cell can be improved and the downlink performance of a UE in the marginal area of the cell can be enhanced.

Since the power of the CRS is adjusted on the basis of a reference, this adjustment can be considered as transparent adjustment for the UE. Therefore, no impact is caused to the UE in measuring a downlink Channel Quality Indicator (CQI) under a full bandwidth, no impact is caused to cell reselection and handover of the UE, and a small impact is caused to an existing network, which facilitates implementation of the disclosure in the existing network.

#### BRIEF DESCRIPTION OF THE DRAWINGS

FIG. 1 shows a diagram of dividing each cell into a central area and a marginal area in existing ICIC technology;

FIG. 2 shows a diagram of frequency domain division in the frequency-domain based ICIC in the related art;

FIG. 3 shows a diagram of time domain division in the time-domain based ICIC in the related art;

FIG. 4 shows a diagram of CRS-REs of adjacent cells staggered in frequency domain positions in the related art;

4

FIG. 5 shows a flowchart of a method for configuring a CRS provided by an embodiment of the disclosure;

FIG. 6 shows a diagram of a CRS provided by an embodiment of the disclosure;

FIG. 7 shows a structure diagram of an apparatus for configuring a CRS provided by an embodiment of the disclosure;

FIG. 8 shows a first diagram of the structure of a configuration unit provided by an embodiment of the disclosure; and

FIG. 9 shows a second diagram of the structure of a configuration unit provided by an embodiment of the disclosure.

#### DETAILED DESCRIPTION

Specific implementation of the method and the apparatus for configuring a CRS provided by the embodiments of the disclosure are elaborated below with reference to the drawings.

A method for configuring a CRS provided by an embodiment of the disclosure is elaborated first.

The method for configuring a CRS provided by an embodiment of the disclosure includes: the power of the CRS is adjusted on the basis of dividing a cell into a central area and a marginal area in the existing ICIC technology and adjusting the power of dedicated channels (a PDSCH bearing UE dedicated data and a PDCCH bearing UE dedicated scheduling information) of a marginal area and a central area of a cell. The method, as shown in FIG. 5, includes:

**S501:** A cell is divided into a central area and a marginal area.

**S502:** A CRS is divided into a central CRS, a marginal CRS and a common CRS.

In **S501**, on the basis of dividing the cell into the central area and the marginal area, the central CRS is a CRS which is located on a transmission resource section used in the central area of the cell and which is on the same symbol as a dedicated channel of the central area;

the marginal CRS is a CRS which is located on a transmission resource section used in the marginal area of the cell and which is on the same symbol as the dedicated channel of the marginal area; and

the common CRS is a CRS, except for the central CRS and the marginal CRS, which is adjacent to a downlink common channel in frequency domain and which is on the same symbol as the downlink common channel.

The dedicated channels include but are not limited to: a PDSCH bearing UE dedicated data (hereinafter referred to as "dedicated PDSCH" in brief) and a PDCCH bearing UE dedicated scheduling information (hereinafter referred to as "dedicated PDCCH" in brief).

The common channel includes but is not limited to: a PBCH, a PCFICH, a PHICH, a PDCCH bearing scheduling information of a BCH and a PCH (hereinafter referred to as "common PDCCH" in brief), and a PDSCH bearing data of a BCH and a PCH (hereinafter referred to as "common PDSCH" in brief).

Take a CRS in the mode of two antenna ports shown in FIG. 6 for an example, the vertical axis represents a time shaft, and the horizontal axis represents a frequency domain shaft. The small squares with patterns indicates CRSs. That the CRS is on a same symbol as the dedicated channel or common channel refers to that the CRS has the same position as the dedicated channel on the time shaft.

**S503:** A value that is obtained by adding a fixed first power value to a preset reference Energy Per Resource Element (EPRE) is configured as an EPRE value of the marginal CRS.



**S504:** A value that is obtained by subtracting a fixed second power value from the preset reference EPRE is configured as an EPRE value of the central CRS.

**S505:** The reference EPRE is configured as the EPRE value of the common CRS.

In **S503** and **S504**, the values of the first power and the second power can be directly set to the adjusted power value of an EPRE of the dedicated channel in the existing ICIC technology, or can also be adjusted on the basis of the adjusted power value of the EPRE of the dedicated channel in the existing ICIC technology in conjunction with system simulation and network testing. Specifically, two conditions are included as follows.

Condition 1:

In the condition that transmission resources are based on frequency domain, only the EPREs of the dedicated PDSCHs of the marginal area and central area of the cell are adjusted on the basis of a reference power in the existing ICIC technology while the EPRE of the dedicated PDCCH is directly set as the reference power without adjusting the EPRE of the dedicated PDCCH. Therefore, the adjusted power values of the EPREs of the central CRS and the marginal CRS can refer to the adjusted power value of the EPRE of the dedicated PDSCH.

First, a first difference (N1) between the EPRE of the dedicated PDSCH of the marginal area of the cell and the reference EPRE that are set according to the existing ICIC technology is determined, and a second difference (N2) between the EPRE of the dedicated PDSCH of the central area of the cell and the reference EPRE that are set according to the existing ICIC technology is determined.

Assume that the first power value by which the EPRE of the marginal CRS needs to be raised is M1 and that the second power value by which the EPRE of the central CRS needs to be reduced is M2.

Mode 1: M1 is set directly to N1 and M2 is set directly to N2. That is, a fixed power difference is kept between the adjusted marginal CRS and the dedicated PDSCH of the marginal area of the cell. In this way, since in existing ICIC technology the adjusted value of the dedicated channel can already achieve the purpose of reducing interference on a neighbour cell and not impacting the performance of the dedicated channel of the central area of the cell, the direct use of the adjusted value on one hand can achieve a similar technical effect and on the other hand can avoid transmitting a new power difference between the CRS and the PDSCH to a UE in the cell, thereby saving some signalling overhead.

Mode 2: according to a result of system simulation and network testing, adjustment is made on the basis of N1 to obtain M1, and adjustment is made on the basis of N2 to obtain M2.

If the adjustment amount of the marginal CRS (or the central CRS) is inconsistent with that of the dedicated PDSCH of the marginal area of the cell (or the dedicated PDSCH of the central area of the cell) which is on the same symbol as the marginal CRS, the power difference between the adjusted CRS and the dedicated PDSCH would be changed. At this moment, it is also needed to inform, through a signalling reconfiguration message, the UE in the cell of the new EPRE power difference between the dedicated PDSCH of the marginal area of the cell and the marginal CRS and the new EPRE power difference between the dedicated PDSCH of the central area of the cell and the central CRS.

No matter Mode 1 or Mode 2 is adopted, the values of N1, M1, N2 and M2 must satisfy that: the sum of respective configured powers of the dedicated PDSCH of the central area of the cell and the central CRS, the dedicated PDSCH of the marginal area of the cell and the marginal CRS, the com-

mon CRS and the common channel of the cell is, on the same symbol, not greater than the maximum power of the cell.

Condition 2:

In the condition that transmission resources are based on time domain, the EPREs of the dedicated PDSCH and the dedicated PDCCH of the central area or marginal area of the cell are adjusted on the basis of a reference power in the existing ICIC technology, respectively. Therefore, in this condition, the adjusted power values of EPRE of the central CRS and the marginal CRS which are on the same symbol as the dedicated PDSCH can refer to the adjusted power value of EPRE of the dedicated PDSCH of the central area and the marginal area of the cell respectively. And, the adjusted power values of the EPREs of the central CRS and the marginal CRS which are on the same symbol as the dedicated PDCCH can refer to the adjusted power values of the EPREs of the dedicated PDCCHs of the central area and the marginal area of the cell respectively.

Specifically, a first difference (N1) between the EPRE of the dedicated PDSCH of the marginal area of the cell and the reference EPRE that are set according to the existing ICIC technology is determined, a second difference (N2) between the EPRE of the dedicated PDSCH of the central area of the cell and the reference EPRE that are set according to the existing ICIC technology is determined, a third difference (N3) between the EPRE of the dedicated PDCCH of the marginal area of the cell and the reference EPRE that are set according to the existing ICIC technology is determined, and a fourth difference (N4) between the EPRE of the dedicated PDCCH of the central area of the cell and the reference EPRE that are set according to the existing ICIC technology is determined.

Similar to Condition 1, the first power value of the EPRE of the marginal CRS which is on the same symbol as the dedicated PDSCH of the marginal area of the cell (i.e., the power value needed to be adjusted relative to the reference power value, M1), the second power value (M2) of the EPRE of the central CRS which is on the same symbol as the dedicated PDSCH of the central area of the cell, the first power value (M3) of the EPRE of the marginal CRS which is on the same symbol as the dedicated PDCCH of the marginal area of the cell, and the second power value (M4) of the EPRE of central CRS which is on the same symbol as the dedicated PDCCH of the central area of the cell can also be configured through the following two modes.

Mode 1: M1 is set directly to N1, M2 is set directly to N2, M3 is set directly to N3, and M4 is set directly to N4. That is, a fixed power difference is kept between the adjusted marginal CRS and the dedicated PDSCH or dedicated PDCCH of the marginal area of the cell which is on the same symbol as the marginal CRS, and a fixed power difference is kept between the adjusted central CRS and the dedicated PDSCH or dedicated PDCCH of the central area of the cell which is on the same symbol as the central CRS. In this way, on one hand, interference of the central CRS on a neighbour cell can be reduced without impacting the performance of the central CRS of the cell; on the other hand, it is not necessary to inform the UE of the power difference, thereby saving some signal overhead.

Mode 2: according to a result of system simulation and network testing, adjustment is made on the basis of N1 to obtain M1, and adjustment is made on the basis of N2 to obtain M2, adjustment is made on the basis of N3 to obtain M3, and adjustment is made on the basis of N4 to obtain M4.

Similar to Condition 1, in Mode 2, since the power difference between the CRS and the PDSCH which is on the same symbol as the CRS is changed compared with that before

configuration, it is also needed to inform, through a signalling reconfiguration message, the UE in the cell of a power difference between the configured EPRE of the dedicated PDSCH of the marginal area of the cell and the configured EPRE of the marginal CRS which is on the same symbol as the dedicated PDSCH and a power difference between the configured EPRE of the dedicated PDSCH of the central area of the cell and the configured EPRE of the central CRS which is on the same symbol as the dedicated PDSCH.

No matter Mode 1 or Mode 2 is adopted, the values of N1, M1, N2, M2, N3, M3, N4 and M4 must satisfy that: the sum of respective configured powers of the dedicated PDSCH of the central area of the cell and the central CRS which is on the same symbol as the dedicated PDSCH, the dedicated PDSCH of the marginal area of the cell and the marginal CRS which is on the same symbol as the dedicated PDSCH, the dedicated PDCCH of the central area of the cell and the central CRS which is on the same symbol as the dedicated PDCCH, the dedicated PDCCH of the marginal area of the cell and the marginal CRS which is on the same symbol as the dedicated PDCCH, the common PDCCH, the common CRS and the common channel of the cell is, on the same symbol, not greater than the maximum power of the cell.

In order to better illustrate the method for configuring a CRS provided by the embodiment of the disclosure, examples of transmission resources based on frequency domain and time domain are provided below respectively.

#### Example 1

In Example 1, transmission resources are divided based on frequency domain.

A specific configuration process is as follows.

It is assumed that the frequency bandwidth of an LTE cell is 20 MHz, in which there are 100 available Resource Blocks (RBs), i.e., 1200 REs, Cyclic Prefix (CP) adopts a normal CP, the base station has 2 antennas, and the maximum transmitting power is 40 W, i.e., 46 dBm.

Before implementing ICIC, it is assumed that the reference power EPRE of the CRS EPRE (CRS-RE) is 12 dBm, and the difference value of the power of PDSCH-RE relative to the reference power of CRS-RE is set to 0 dB, i.e., the power of PDSCH-RE is set to 12 dBm. Therefore, the total power of the PDSCH and the CRS which is on the same symbol as the PDSCH is:  $12+10*\text{Log } 1200=42.79$  dBm, which is less than the maximum power (46 dBm) of the cell. Thus, power overload would not occur.

During implementing ICIC, a cell is divided into a central area and a marginal area, wherein the marginal area is allocated with frequency band resources of 30 RBs, the central area is allocated with frequency band resources of 60 RBs (if not occupied, the frequency band resources of the marginal area can be temporarily turned into frequency band resources of the central area to be used), and the rest 10 RBs are reserved for the downlink common channel and the common CRS, wherein the 10 RBs are located between the frequency band of the marginal area and the frequency band of the central area. Since division of central area and marginal area is made only for the dedicated PDSCH in the ICIC based on frequency domain, only the CRS which is on the same symbol as the PDSCH is divided. Therefore, it can be obtained that the marginal CRS has  $30*4=120$  REs, the marginal PDSCH has  $30*8=240$  REs, the central CRS has  $60*4=240$  Res, and the central PDSCH has  $60*8=480$  REs.

Both the power of the PDSCH-RE in the 30-RB frequency band of the marginal area and the power of the CRS-RE which

is on the same symbol as the PDSCH-RE are raised by 3 dB on the basis of the original reference power, i.e., becoming 15 dBm.

Both the power of the PDSCH-RE in the 60-RB frequency band of the central area and the power of the CRS-RE which is on the same symbol as the PDSCH-RE are reduced by 3 dB on the basis of the original reference power, i.e., becoming 9 dBm.

Both the power of the common PDSCH and the power of the common CRS in the rest 10-RB frequency band are not adjusted, and are still kept at 12 dBm.

The total power of the adjusted PDSCH and the adjusted CRS which is on the same symbol as the PDSCH is:  $10*\text{Log } (10^{12}*(15/10)*120+10^{15}*(15/10)*240+10^9*(9/10)*240+10^9*(9/10)*480+10^{12}*(12/10)*120)=42.79$  dBm, which is still less than the maximum power (46 dBm), thus power overload would not occur.

#### Example 2

In Example 2, transmission resources are divided based on time domain.

A specific configuration process is as follows.

It is assumed that the frequency bandwidth of an LTE cell is 20 MHz, in which there are 100 available Resource Blocks (RBs), i.e., 1200 REs, Cyclic Prefix (CP) adopts a normal CP, the base station has 2 antennas, and the maximum transmitting power is 40 W, i.e., 46 dBm.

If in LTE of Frequency Division Duplex (FDD) mode, one downlink radio frame contains 10 downlink radio Sub Frames (SFs): SF0-SF9; if in LTE of Time Division Duplex (TDD) mode, it is assumed that uplink and downlink configurations are 1, one radio frame contains 6 downlink SFs (SF0, SF1, SF4, SF5, SF6, SF9) and 4 uplink SFs (SF2, SF3, SF7, SF8). Hereinafter, the disclosure is described below by taking FDD as an example (SFs are fewer in the TDD mode; it is more complex to implement the ICIC based on time domain, but the principle is similar, which is not further repeated here).

Before implementing ICIC, it is assumed that the reference power EPRE of CRS-RE is 12 dBm, the difference values of the power of PDCCH-RE, PBCH-RE, PCHICH-RE, PHICH-RE and PDSCH-RE relative to the reference power of CRS-RE are set to 0 dB respectively, that is, the powers of PDCCH-RE, PBCH-RE, PCHICH-RE, PHICH-RE and PDSCH-RE are set to 12 dBm respectively. Therefore, no matter for the symbol on which the PDCCH is located or for the symbol on which the PDSCH is located, the total power is:  $12+10*\text{Log } 1200=42.79$  dBm, which is less than the maximum power (46 dBm) of the cell, thus power overload would not occur.

During implementing ICIC, a cell is divided into a central area and a marginal area, wherein the marginal area is allocated with time segment resources of 3 SFs, the central area is allocated with time segment resources of 6 SFs (if not occupied, the time segment resources of the marginal area can be temporarily turned into time segment resources of the central area to be used), and the rest 1-SF time segment resources are reserved for the common channel and the common CRS. Due to the characteristic of scheduling process, the marginal area time segment resources of the PDCCH differ by 4 SFs from that of the PDSCH, and the central area time segment resources of the PDCCH also differ by 4 SFs from that of the PDSCH. For example, if the PDCCH downlink time segments allocated to the marginal area are "SF1 & SF2 & SF3", then PDSCH downlink time segments are "SF5 & SF6 & SF7"; if the PDCCH downlink time segments allocated to the central area are "SF4 & SF5 & SF6 & SF7 & SF8 & SF9", then PDSCH downlink time segments are "SF8 & SF9 & SF0

& SF1 & SF2 & SF3"; and SF0 is allocated to the downlink common PDCCH, and SF4 is allocated to the downlink common PDSCH.

The power of the dedicated PDCCH in the central area SFs of PDCCH and the power of the central CRS which is on the same symbol as the dedicated PDCCH, and the power of the dedicated PDSCH in the central area SFs of PDSCH and the power of the central CRS which is on the same symbol as the dedicated PDSCH all are reduced by 3 dB or more on the basis of the reference power, while the power of the common channel (such as, the PBCH, the PCFICH, the PHICH, the common PDCCH, or the common PDSCH) and the power of the common CRS which is adjacent to the common channel in frequency domain and is on the same symbol as the common channel keep unchanged. Since power is reduced, it is impossible to appear power overload.

The power of the dedicated PDCCH in the marginal area SFs of PDCCH and the power of the marginal CRS which is on the same symbol as the dedicated PDCCH, and the power of the dedicated PDSCH in the marginal area SF of PDSCH and the power of the marginal CRS is on the same symbol as the dedicated PDSCH all are raised by 3 dB on the basis of the reference power, while the power of the common channel (such as, the PBCH, the PCFICH, the PHICH, the common PDCCH, or the common PDSCH) and the power of the common CRS which is adjacent to the common channel in frequency domain and is on the same symbol as the common channel keep unchanged or are raised by 3 dB, then, the maximum total power on the symbol on which the CRS is located is:  $42.79+3=45.79$  dBm, which is still less than the maximum power (46 dBm), thus power overload would not occur.

For the common downlink PDCCH and the common downlink PDSCH in SF0 and SF4, and the common CRS which is on the same symbol as the PDCCH and the PDSCH and is adjacent to the PDCCH and the PDSCH in frequency domain, their powers are not adjusted and are still 12 dBm respectively, thus power overload would not occur.

From another perspective, the method for configuring a CRS provided by the embodiment of the disclosure enables the marginal CRS to borrow the power of the central CRS, in this way, power sharing is realized, and the difference in coverage between the central area and the marginal area is reduced. Thus, the coverage of the cell is more even, the fairness of cell coverage is improved and the utilization efficiency of power is improved. In addition, since the power of the marginal CRS of the cell is enhanced, co-channel interference on the marginal CRS of the cell from a channel, which is on the same symbol as the marginal CRS in a neighbour cell is reduced. Thus, the downlink performance of the UE in the marginal area of the cell is significantly improved under the premise of not impacting the function of the CRS.

Since only the power of the CRS is adjusted, it is equivalent that amplitude weighting is performed on the CRS, which is similar to construct a virtual radio transmission channel having a special amplitude-frequency response characteristic (the amplitude-frequency response of the central transmission resource section is low, and the amplitude-frequency response of the marginal transmission resource section is high) before a real radio transmission channel. For a UE, the adjustment can be considered as transparent. If all cells in a network adopt this method, no impact would be caused to the UE in the measurement of downlink CQI under full bandwidth, and no impact would be caused to cell reselection and handover of the UE. Moreover, since the UE supports the measurement of sub-band CQI of part bandwidths, no problem would be caused to the demodulation of downlink signal

performed by UE based on CRS channel estimation. In addition, since an eNB knows the power adjustment of the CRS in the cell, impact can be eliminated through a compensation algorithm, so as to restore the real condition of a radio transmission channel. The method for configuring a CRS provided by the embodiment of the disclosure has little impact on the existing network, which can be neglected basically, thus facilitating implementation of the method in the existing network.

Based on the same idea of the disclosure, an embodiment of the disclosure also provides an apparatus for configuring a CRS. Since the principle of the apparatus for configuring a CRS in solving a problem is similar to the method for configuring a CRS, the implementation of the apparatus can refer to the implementation of the above method, which is not repeated.

An apparatus for configuring a CRS provided by an embodiment of the disclosure, as shown in FIG. 7, includes:

a cell division unit **701**, configured to divide a cell into a central area and a marginal area;

a CRS division unit **702**, configured to divide the CRS into a central CRS, a marginal CRS and a common CRS, wherein the central CRS is a CRS which is located on a transmission resource section used in the central area of the cell and is on a same symbol as a dedicated channel of the central area; the marginal CRS is a CRS which is located on a transmission resource section used in the marginal area of the cell and is on a same symbol as a dedicated channel of the marginal area; and the common CRS is a CRS, except for the central CRS and the marginal CRS, which is adjacent to a downlink common channel in frequency domain and is on the same symbol as the downlink common channel; and

a configuration unit **703**, configured to: configure a value that is obtained by adding a fixed first power value to a preset EPRE, as an EPRE value of the marginal CRS; configure a value that is obtained by subtracting a fixed second power value from the preset reference EPRE, as an EPRE value of the central CRS; and configure the reference EPRE as an EPRE value of the common CRS.

In the condition that the transmission resources are divided based on frequency domain, the configuration unit **703**, as shown in FIG. 8, further includes: a determination subunit **801** and a value setting subunit **802**.

Mode 1:

The determination subunit **801** is configured to determine a first difference between an EPRE of a preset dedicated PDSCH of the marginal area of the cell and the reference EPRE, and determine a second difference between an EPRE of a preset dedicated PDSCH of the central area of the cell and the reference EPRE.

The value setting subunit **802** is configured to set the first difference as the first power value and set the second difference as the second power value.

Mode 2:

The determination subunit **801** is configured to determine a first difference between an EPRE of a preset dedicated PDSCH of the marginal area of the cell and the reference EPRE, and determine a second difference between an EPRE of a preset dedicated PDSCH of the central area of the cell and the reference EPRE.

The value setting subunit **802** is configured to, according to a result of system simulation and network testing, adjust the first difference to obtain the first power value and adjust the second difference to obtain the second power value.

In Mode 2, the apparatus for configuring a CRS provided by the embodiment of the disclosure, as shown in FIG. 7, further includes: a signalling reconfiguration message trans-

mitting unit **704**, configured to inform, through a signalling reconfiguration message, a UE in the cell of a power difference between the configured EPRE of the dedicated PDSCH of the marginal area of the cell and the configured EPRE of the marginal CRS which is on the same symbol as the dedicated PDSCH and a power difference between the configured EPRE of the dedicated PDSCH of the central area of the cell and the configured EPRE of the central CRS which is on the same symbol as the dedicated PDSCH.

In this condition, no matter Mode 1 or Mode 2 is adopted, the first difference, the first power value, the second difference and the second power value must satisfy that: the sum of powers of the configured dedicated PDSCH of the central area of the cell and the configured central CRS, the configured dedicated PDSCH of the marginal area of the cell and the configured marginal CRS, the configured common CRS and the configured common channel of the cell is, on a same symbol, not greater than the maximum power of the cell.

In the condition that the transmission resources are divided based on time domain, the configuration unit **703**, as shown in FIG. 9, further includes: a determination subunit **901** and a value setting subunit **902**.

Mode 1:

The determination sub-unit **901** is configured to: determine a first difference between an EPRE of a preset dedicated PDSCH of the marginal area of the cell and the reference EPRE; determine a second difference between an EPRE of a preset dedicated PDSCH of the central area of the cell and the reference EPRE; determine a third difference between an EPRE of a preset dedicated PDCCH of the marginal area of the cell and the reference EPRE; and determine a fourth difference between an EPRE of a preset dedicated PDCCH of the central area of the cell and the reference EPRE.

The value setting subunit **902** is configured to: set the first difference as a first power value of a marginal CRS which is on the same symbol as the dedicated PDSCH; set the second difference as a second power value of a central CRS which is on the same symbol as the dedicated PDSCH; set the third difference as a first power value of a marginal CRS which is on the same symbol as the dedicated PDCCH; and set the fourth difference as a second power value of a central CRS which is on the same symbol as the dedicated PDCCH.

Mode 2:

The determination sub-unit **901** is configured to: determine a first difference between an EPRE of a preset dedicated PDSCH of the marginal area of the cell and the reference EPRE; determine a second difference between an EPRE of a preset dedicated PDSCH of the central area of the cell and the reference EPRE; determine a third difference between an EPRE of a preset dedicated PDCCH of the marginal area of the cell and the reference EPRE; and determine a fourth difference between an EPRE of a preset dedicated PDCCH of the central area of the cell and the reference EPRE.

The value setting subunit **902** is configured to: according to a result of system simulation and network testing, adjust the first difference, the second difference, the third difference and the fourth difference respectively to obtain the first power value of the marginal CRS which is on the same symbol as the dedicated PDSCH, the second power value of the central CRS which is on the same symbol as the dedicated PDSCH, the first power value of the marginal CRS which is on the same symbol as the dedicated PDCCH and the second power value of the central CRS which is on the same symbol as the dedicated PDCCH.

In Mode 2, similar to Mode 1, the configuration apparatus for configuring a CRS provided by the embodiment of the disclosure, as shown in FIG. 7, further includes: a signalling

reconfiguration message transmitting unit **704**, configured to inform, through a signalling reconfiguration message, a User Equipment (UE) in the cell of a power difference between the configured EPRE of the dedicated PDSCH of the marginal area of the cell and the configured EPRE of the marginal CRS which is on the same symbol as the dedicated PDSCH and a power difference between the configured EPRE of the dedicated PDSCH of the central area of the cell and the configured EPRE of the central CRS which is on the same symbol as the dedicated PDSCH.

In this condition, no matter Mode 1 or Mode 2 is adopted, the first difference, the first power value of the marginal CRS which is on the same symbol as the dedicated PDSCH, the second difference, the second power value of the central CRS which is on the same symbol as the dedicated PDSCH, the third difference, the first power value of the marginal CRS which is on the same symbol as the dedicated PDCCH, the fourth difference, and the second power value of the central CRS which is on the same symbol as the dedicated PDCCH satisfy that: the sum of powers of the configured dedicated PDCCH, the configured dedicated PDSCH of the central area of the cell, the configured central CRS, the configured dedicated PDCCH, the configured dedicated PDSCH of the marginal area of the cell, the configured marginal CRS, the configured common CRS and the configured common channel of the cell is, on a same symbol, not greater than the maximum power of the cell.

Obviously, those skilled in the art can make various modifications and variations to the disclosure without departing from the concept and scope of the disclosure. Thus, if these modifications and variations of the disclosure fall within the scope of the claims of the disclosure and equivalent technologies thereof, the disclosure is also intended to include these modifications and variants.

## INDUSTRIAL APPLICABILITY

With the method and the apparatus for configuring a CRS provided by the embodiments of the disclosure, the CRS is divided into a central CRS, a marginal CRS and a common CRS on the basis of dividing a cell into a central area and a marginal area in the existing ICIC technology, wherein the EPRE of the central CRS is reduced by certain power on the basis of a preset reference EPRE, and the EPRE of the marginal CRS is raised by certain power on the basis of the preset reference EPRE. Therefore, without affecting the downlink performance of a UE in the central area of a cell, an SINR of a marginal area of the cell can be improved and the downlink performance of a UE in the marginal area of the cell can be enhanced.

Since the power of the CRS is adjusted on the basis of a reference, this adjustment can be considered as transparent adjustment for the UE. Therefore, no impact is caused to the UE in measuring a downlink Channel Quality Indicator (CQI) under a full bandwidth, no impact is caused to cell reselection and handover of the UE, and a small impact is caused to an existing network, which facilitates implementation of the disclosure in the existing network.

The invention claimed is:

1. A method for configuring a Cell-Specific Reference Signal (CRS) in a cell including a central area and a marginal area, wherein the central area is an area in which a difference value of Reference Signal Received Power (RSRP) between the cell and a neighbour cell is higher than a predefined threshold and the marginal area is an area in which the difference value of Reference Signal Received Power (RSRP)

between the cell and the neighbour cell is lower than the predefined threshold, the method comprising:

- dividing the CRS into a central CRS, a marginal CRS and a common CRS, wherein the central CRS is a CRS which is located on a transmission resource section used in the central area of the cell and is on a same symbol as a dedicated channel of the central area; the marginal CRS is a CRS which is located on a transmission resource section used in the marginal area of the cell and is on a same symbol as a dedicated channel of the marginal area; and the common CRS is a CRS, except for the central CRS and the marginal CRS, which is adjacent to a downlink common channel in frequency domain and is on a same symbol as the downlink common channel;
- configuring a value that is obtained by adding a fixed first power value to a preset reference Energy Per Resource Element (EPRE), as an EPRE value of the marginal CRS;
- configuring a value that is obtained by subtracting a fixed second power value from the preset reference EPRE, as an EPRE value of the central CRS;
- configuring the reference EPRE as an EPRE value of the common CRS; and
- receiving and transmitting data between the cell and a User Equipment (UE) with respect to the configured values.

2. The method according to claim 1, wherein the dedicated channel comprises:

- a Physical Downlink Shared Channel (PDSCH) bearing User Equipment (UE) dedicated data and a Physical Downlink Control Channel (PDCCH) bearing UE dedicated scheduling information.

3. The method according to claim 2, wherein when the transmission resource is frequency domain resource, the first power value and the second power value are determined through:

- determining a first difference between an EPRE of a preset dedicated PDSCH of the marginal area of the cell and the reference EPRE, and determining a second difference between an EPRE of a preset dedicated PDSCH of the central area of the cell and the reference EPRE; and
- setting the first difference as the first power value, and setting the second difference as the second power value; wherein the first difference, the first power value, the second difference and the second power value satisfy that: a sum of, a configured power of the dedicated PDSCH of the central area of the cell and a configured power of the central CRS, a configured power of the dedicated PDSCH of the marginal area of the cell and a configured power of the marginal CRS, and a configured power of the common CRS and a configured power of the common channel of the cell is, on a same symbol, not greater than a maximum power of the cell.

4. The method according to claim 2, wherein when the transmission resource is frequency domain resource, the first power value and the second power value are determined through:

- determining a first difference between an EPRE of a preset dedicated PDSCH of the marginal area of the cell and the reference EPRE, and determining a second difference between an EPRE of a preset dedicated PDSCH of the central area of the cell and the reference EPRE; and
- according to a result of system simulation and network testing, adjusting the first difference to obtain the first power value, and adjusting the second difference to obtain the second power value;
- wherein the first difference, the first power value, the second difference and the second power value satisfy that: a

sum of, a configured power of the dedicated PDSCH of the central area of the cell and a configured power of the central CRS, a configured power of the dedicated PDSCH of the marginal area of the cell and a configured power of the marginal CRS, and a configured power of the common CRS and a configured power of the common channel of the cell is, on a same symbol, not greater than a maximum power of the cell.

5. The method according to claim 2, wherein when the transmission resource is time domain resource, the first power value and the second power value are determined through:

- determining a first difference between an EPRE of a preset dedicated PDSCH of the marginal area of the cell and the reference EPRE;
- setting the first difference as a first power value of a marginal CRS which is on the same symbol as the dedicated PDSCH;
- determining a second difference between an EPRE of a preset dedicated PDSCH of the central area of the cell and the reference EPRE;
- setting the second difference as a second power value of a central CRS which is on the same symbol as the dedicated PDSCH;
- determining a third difference between an EPRE of a preset dedicated PDCCH of the marginal area of the cell and the reference EPRE;
- setting the third difference as a first power value of a marginal CRS which is on the same symbol as the dedicated PDCCH;
- determining a fourth difference between an EPRE of a preset dedicated PDCCH of the central area of the cell and the reference EPRE; and
- setting the fourth difference as a second power value of a central CRS which is on the same symbol as the dedicated PDCCH;

wherein the first difference, the first power value of the marginal CRS which is on the same symbol as the dedicated PDSCH, the second difference, the second power value of the central CRS which is on the same symbol as the dedicated PDSCH, the third difference, the first power value of the marginal CRS which is on the same symbol as the dedicated PDCCH, and the fourth difference and the second power value of the central CRS which is on the same symbol as the dedicated PDCCH satisfy that: a sum of, a configured power of the dedicated PDCCH of the central area of the cell and a configured power of the dedicated PDSCH of the central area of the cell and a configured power of the central CRS, a configured power of the dedicated PDCCH of the marginal area of the cell and a configured power of the dedicated PDSCH of the marginal area of the cell and a configured power of the marginal CRS, and a configured power of the common CRS and a configured power of the common channel of the cell is, on a same symbol, not greater than a maximum power of the cell.

6. The method according to claim 2, wherein when the transmission resource is time domain resource, the first power value and the second power value are determined through:

- determining a first difference between an EPRE of a preset dedicated PDSCH of the marginal area of the cell and the reference EPRE; determining a second difference between an EPRE of a preset dedicated PDSCH of the central area of the cell and the reference EPRE; determining a third difference between an EPRE of a preset dedicated PDCCH of the marginal area of the cell and the reference EPRE; and determining a fourth difference

15

between an EPRE of a preset dedicated PDCCH of the central area of the cell and the reference EPRE; and according to a result of system simulation and network testing, adjusting the first difference, the second difference, the third difference and the fourth difference respectively to obtain the first power value of the marginal CRS which is on the same symbol as the dedicated PDSCH, the second power value of the central CRS which is on the same symbol as the dedicated PDCCH and the second power value of the central CRS which is on the same symbol as the dedicated PDCCH;

wherein the first difference, the first power value of the marginal CRS which is on the same symbol as the dedicated PDSCH, the second difference, the second power value of the central CRS which is on the same symbol as the dedicated PDSCH, the third difference, the first power value of the marginal CRS which is on the same symbol as the dedicated PDCCH, and the fourth difference and the second power value of the central CRS which is on the same symbol as the dedicated PDCCH satisfy that: a sum of, a configured power of the dedicated PDCCH of the central area of the cell and a configured power of the dedicated PDSCH of the central area of the cell and a configured power of the marginal area of the cell and a configured power of the marginal CRS, and a configured power of the common CRS and a configured power of the common channel of the cell is, on a same symbol, not greater than a maximum power of the cell.

7. The method according to claim 4, further comprising: informing, through a signalling reconfiguration message, a UE in the cell of a power difference between the configured EPRE of the dedicated PDSCH of the marginal area of the cell and the configured EPRE of the marginal CRS which is on the same symbol as the dedicated PDSCH and a power difference between the configured EPRE of the dedicated PDSCH of the central area of the cell and the configured EPRE of the central CRS which is on the same symbol as the dedicated PDSCH.

8. An apparatus for configuring a Cell-Specific Reference Signal (CRS) in a cell including

a central area and a marginal area, wherein the central area is an area in which a difference value of Reference Signal Received Power (RSRP) between the cell and a neighbour cell is higher than a predefined threshold and the marginal area is an area in which the difference value of Reference Signal Received Power (RSRP) between the cell and the neighbour cell is lower than the predefined threshold, the apparatus comprising;

a CRS division unit, configured to divide the CRS into a central CRS, a marginal CRS and a common CRS, wherein the central CRS is a CRS which is located on a transmission resource section used in the central area of the cell and is on a same symbol as a dedicated channel of the central area; the marginal CRS is a CRS which is located on a transmission resource section used in the marginal area of the cell and is on a same symbol as a dedicated channel of the marginal area; and the common CRS is a CRS, except for the central CRS and the marginal CRS, which is adjacent to a downlink common channel in frequency domain and is on the same symbol as the downlink common channel;

16

a configuration unit, configured to: configure a value that is obtained by adding a fixed first power value to a preset reference Energy Per Resource Element (EPRE), as an EPRE value of the marginal CRS; configure a value that is obtained by subtracting a fixed second power value from the preset reference EPRE, as an EPRE value of the central CRS; and configure the reference EPRE as an EPRE value of the common CRS; and

the apparatus configured to receive and transmit data between the cell and a User Equipment (UE) with respect to the configured values.

9. The apparatus according to claim 8, wherein the configuration unit comprises:

a determination subunit, configured to determine a first difference between an EPRE of a preset dedicated Physical Downlink Shared Channel (PDSCH) of the marginal area of the cell and the reference EPRE, and determine a second difference between an EPRE of a preset dedicated PDSCH of the central area of the cell and the reference EPRE; and

a value setting subunit, configured to set the first difference as the first power value and set the second difference as the second power value;

wherein the first difference, the first power value, the second difference and the second power value satisfy that: a sum of, a configured power of the dedicated PDSCH of the central area of the cell and a configured power of the central CRS, a configured power of the dedicated PDSCH of the marginal area of the cell and a configured power of the marginal CRS, and a configured power of the common CRS and a configured power of the common channel of the cell is, on a same symbol, not greater than a maximum power of the cell.

10. The apparatus according to claim 8, wherein the configuration unit comprises:

a determination subunit, configured to determine a first difference between an EPRE of a preset dedicated PDSCH of the marginal area of the cell and the reference EPRE, and determine a second difference between an EPRE of a preset dedicated PDSCH of the central area of the cell and the reference EPRE; and

a value setting subunit, configured to, according to a result of system simulation and network testing, adjust the first difference to obtain the first power value and adjust the second difference to obtain the second power value;

wherein the first difference, the first power value, the second difference and the second power value satisfy that: a sum of, a configured power of the dedicated PDSCH of the central area of the cell and a configured power of the central CRS, a configured power of the dedicated PDSCH of the marginal area of the cell and a configured power of the marginal CRS, and a configured power of the common CRS and a configured power of the common channel of the cell is, on a same symbol, not greater than a maximum power of the cell.

11. The apparatus according to claim 8, wherein the configuration unit comprises:

a determination sub-unit, configured to: determine a first difference between an EPRE of a preset dedicated PDSCH of the marginal area of the cell and the reference EPRE; determine a second difference between an EPRE of a preset dedicated PDSCH of the central area of the cell and the reference EPRE; determine a third difference between an EPRE of a preset dedicated Physical Downlink Control Channel (PDCCH) of the marginal area of the cell and the reference EPRE; and determine a

fourth difference between an EPRE of a preset dedicated PDCCH of the central area of the cell and the reference EPRE; and

a value setting subunit, configured to: set the first difference as a first power value of a marginal CRS which is on the same symbol as the dedicated PDSCH; set the second difference as a second power value of a central CRS which is on the same symbol as the dedicated PDSCH; set the third difference as a first power value of a marginal CRS which is on the same symbol as the dedicated PDCCH; and set the fourth difference as a second power value of a central CRS which is on the same symbol as the dedicated PDCCH;

wherein the first difference, the first power value of the marginal CRS which is on the same symbol as the dedicated PDSCH, the second difference, the second power value of the central CRS which is on the same symbol as the dedicated PDSCH, the third difference, the first power value of the marginal CRS which is on the same symbol as the dedicated PDCCH, and the fourth difference and the second power value of the central CRS which is on the same symbol as the dedicated PDCCH satisfy that: a sum of, a configured power of the dedicated PDCCH of the central area of the cell and a configured power of the dedicated PDSCH of the central area of the cell and a configured power of the central CRS, a configured power of the dedicated PDCCH of the marginal area of the cell and a configured power of the dedicated PDSCH of the marginal area of the cell and a configured power of the marginal CRS, and a configured power of the common CRS and a configured power of the common channel of the cell is, on a same symbol, not greater than a maximum power of the cell.

12. The apparatus according to claim 8, wherein the configuration unit comprises:

a determination sub-unit, configured to: determine a first difference between an EPRE of a preset dedicated PDSCH of the marginal area of the cell and the reference EPRE; determine a second difference between an EPRE of a preset dedicated PDSCH of the central area of the cell and the reference EPRE; determine a third difference between an EPRE of a preset dedicated PDCCH of the marginal area of the cell and the reference EPRE; and determine a fourth difference between an EPRE of a preset dedicated PDCCH of the central area of the cell and the reference EPRE; and

a value setting subunit, configured to: according to a result of system simulation and network testing, adjust the first difference, the second difference, the third difference and the fourth difference respectively to obtain the first power value of the marginal CRS which is on the same symbol as the dedicated PDSCH, the second power value of the central CRS which is on the same symbol as the dedicated PDSCH, the first power value of the marginal CRS which is on the same symbol as the dedicated PDCCH and the second power value of the central CRS which is on the same symbol as the dedicated PDCCH;

wherein the first difference, the first power value of the marginal CRS which is on the same symbol as the dedicated PDSCH, the second difference, the second power value of the central CRS which is on the same symbol as the dedicated PDSCH, the third difference, the first power value of the marginal CRS which is on the same symbol as the dedicated PDCCH, and the fourth difference and the second power value of the central CRS which is on the same symbol as the dedicated PDCCH satisfy that: a sum of, a configured power of the dedicated PDCCH of the central area of the cell and a configured power of the dedicated PDSCH of the central area of the cell and a configured power of the central CRS, a configured power of the dedicated PDCCH of the marginal area of the cell and a configured power of the dedicated PDSCH of the marginal area of the cell and a configured power of the marginal CRS, and a configured power of the common CRS and a configured power of the common channel of the cell is, on a same symbol, not greater than a maximum power of the cell.

13. The apparatus according to claim 10, further comprising:

a signalling reconfiguration message transmitting unit, configured to inform, through a signalling reconfiguration message, a User Equipment (UE) in the cell of a power difference between the configured EPRE of the dedicated PDSCH of the marginal area of the cell and the configured EPRE of the marginal CRS which is on the same symbol as the dedicated PDSCH and a power difference between the configured EPRE of the dedicated PDSCH of the central area of the cell and the configured EPRE of the central CRS which is on the same symbol as the dedicated PDSCH.

14. The method according to claim 6, further comprising: informing, through a signalling reconfiguration message, a UE in the cell of a power difference between the configured EPRE of the dedicated PDSCH of the marginal area of the cell and the configured EPRE of the marginal CRS which is on the same symbol as the dedicated PDSCH and a power difference between the configured EPRE of the dedicated PDSCH of the central area of the cell and the configured EPRE of the central CRS which is on the same symbol as the dedicated PDSCH.

15. The apparatus according to claim 12, further comprising:

a signalling reconfiguration message transmitting unit, configured to inform, through a signalling reconfiguration message, a User Equipment (UE) in the cell of a power difference between the configured EPRE of the dedicated PDSCH of the marginal area of the cell and the configured EPRE of the marginal CRS which is on the same symbol as the dedicated PDSCH and a power difference between the configured EPRE of the dedicated PDSCH of the central area of the cell and the configured EPRE of the central CRS which is on the same symbol as the dedicated PDSCH.

\* \* \* \* \*